



Date: September 14, 2023
Report No.: 10.02.16105-1
Revision No.: 0
Project No.: LV-16105
Model No: NB1C, NB1A2, NB1DP, NB56L
Product Type: Lightning Protection Hardware – Anchor
Flanges

Your Partner in Testing and Certification Inc.



205 – 8291 92 Street, Delta, BC
V4G 0A4, Canada
Phone: 604-247-0444
Fax: 604-247-0442
www.labtestcert.com



Date Issued:	Project No:	Client	Report No:	Revision No:
September 14, 2023	LV-16105	Lance Nil, Inc.	10.02.16105-1	0

TABLE OF CONTENTS

REPORT 3
GENERAL TERMS 4
ALTERATION..... 8
MARKING..... 9
EXAMPLE MARKING LABEL 10
PRODUCT DESCRIPTION..... 14
FIGURES / DIAGRAMS 15
PICTURES 19
FACTORY PRODUCTION TESTS 27
DATA SECTION..... 29

Date Issued:	Project No:	Client	Report No:	Revision No:
September 14, 2023	LV-16105	Lance Nill, Inc.	10.02.16105-1	0

REPORT

Certification System	Type 3 (ISO / IEC Guide 17067)
Scope	This report covers the evaluation of Lance Nill, Inc's Class I lightning protection components, anchor flange hardware, for use in the installation of complete systems of lightning protection on buildings and structures. Report inclusive of models NB1C, NB1A2, NB1DP and NB56L.
ICS Code	91.120.40
Report reference No.:	10.02.16105-1

Note: By signing the below, both the Issuer and the Reviewer hereby declare to abide by the applicable LabTest policies:

- 1.) Statement of Independence # 3014 (LabTest Employees), or
- 2.) Independence, Impartiality, and Integrity #1039, clause 11 (Engineering Service Subcontractors).

Complied and Issued by: (print name and signature)	Robert Grady	
Date of issue:	September 14, 2023	
Reviewed by: (print name and signature)	Andrew Bagnall	
Date of Review:	September 14, 2023	

Testing Laboratory (Name):	LabTest Certification, Inc.
Address:	3255 Pepper Lane Suite 112, Las Vegas, Nevada 89120 USA
Testing Location (Name):	LabTest Certification, Inc.
Address:	17727 Commerce Drive #400, Westfield, Indiana 46074 USA
Evaluation/Testing By:	Robert Grady

Applicant's Name:	Lance Nill, Inc.
Contact Person:	Lance Nill
Address:	67 Mariner Drive, Southampton, New York 11968 USA

Test specification	
Standard (Test Specification)	➤ ANSI/CAN/UL 96 (Ed.6): Lightning Protection Components
Conclusion	The submitted test items noted below were found to be in compliance with the above noted standard(s).

Test item description	Class I Lightning Protection Components
Manufacture:	Lance Nill, Inc.
Model No. and Ratings:	Models: ➤ NB1C, NB1A2, NB1DP and NB56L Ratings: ➤ Class I Components

Date Issued:	Project No:	Client	Report No:	Revision No:
September 14, 2023	LV-16105	Lance Nill, Inc.	10.02.16105-1	0

GENERAL TERMS

Test items particulars:

Class I lightning protection components, stainless steel anchor flange hardware, for use in the installation of complete systems of lightning protection on buildings and structures. Report inclusive of models NB1C, NB1A2, NB1DP and NB56L.

Possible test case verdicts

Test case does not apply to the test object : N/A
 Test item does meet the requirement : Pass (P)
 Test item does not meet the requirement .. : Fail (F)

Testing

Conducted at LabTest Certification, Inc.

Date of receipt of test item : July 27, 2023
 Date(s) of evaluation and performance of test ... : August 1, 2023 through August 21, 2023

File Transfer, testing conducted by

Certification Body (CB)
 Report No.
 Report Date

General remarks

This report does not permit the use of the LC mark unless provided with Certificate of Conformity and Authorization Letter to Mark issued by LabTest Certification Inc.

This report shall not be reproduced except in full without the written approval of the testing laboratory. The test results presented in this report relate only to the item(s) tested.

(see remark #)" refers to a remark appended to the report.
 "(see Annex #)" refers to an annex appended to the report.
 Throughout this report a comma is used as the decimal separator.
 Throughout this report a period is used as the decimal separator.

Note:

➤ Models are stainless steel and are Class I hardware components.

Report History:

➤ Rev. 0 – Issued September 14, 2023

Date Issued:	Project No:	Client	Report No:	Revision No:
September 14, 2023	LV-16105	Lance Nill, Inc.	10.02.16105-1	0

General Requirements and Definitions

The Applicant and Manufacturer have agreed to produce, test and label LabTest Certification Inc. listed products in accordance with the requirements of this Report. The Applicant and Manufacturer have also agreed to notify LabTest Certification Inc. and to request authorization in writing prior to using alternate parts, components or materials.

COMPONENTS

Components used shall be those listed in the LabTest report covering the products specified in the index including any amendments and/or revisions.

LISTING MARK

The LabTest listing mark applied to the products shall either be separable in form, such as labels purchased from LabTest, or on a product nameplate or other media only as specifically authorized by LabTest. Use of this listing mark is subject to the control of LabTest.

In the event that the LabTest representative identifies non-conformance(s) to any provision of this Report, the Applicant shall take one or more of the following actions:

- Correct the non-conformance(s).
- Remove the LabTest Certification Mark from non-conforming product.
- Contact the LabTest Certification Inc. office that issued this Report for additional instructions.

GENERAL DEFINITIONS

Representative samples of the subject project were examined and are described in the body of this report. Unless specifically stated otherwise, the following general definitions, terminology and construction details apply:

Asterisk: In "Certified*" the asterisk denotes that an SCC Accredited Certification Monogram appears in the components.

Asterisk: In "Listed*" the asterisk denotes that an OSHA Accredited NRTL Listing Monogram appears in the components.

Equivalent: The phrase "or equiv" denotes that an alternative equivalent component having similar mechanical and electrical characteristics may be used and, where the original component was Certified and/or Listed/Recognized, must be a Certified and/or Listed/Recognized component. Equivalent means that the component has equivalent mechanical and electrical characteristics and has no impact on the conformity of the product.

Construction Details: For specific construction details, reference shall be made to the following photographs and descriptions. All dimensions are approximate unless specified as exact or within a tolerance. In addition to the specific construction details described in this Report, the following general requirements also apply.

General Construction: The construction of the appliance shall be in accordance with reasonable concepts of safety, substantiality and durability. Component parts shall be well fitted and not show signs of becoming warped, bent, broken or otherwise damaged through normal use.

Displacement of Parts: Every part of the appliance shall be designed to be secure against displacement and constructed to maintain a fixed relationship between essential parts under normal and reasonable

Date Issued:	Project No:	Client	Report No:	Revision No:
September 14, 2023	LV-16105	Lance Nill, Inc.	10.02.16105-1	0

conditions of handling and usage. Simulated logs and/or coal pieces are a functional part of the burner and shall be secured in position.

Materials: Materials used in the construction of appliances shall have strength, durability, resistance to corrosion.

Exposed Edges: Exposed edges, which may come in contact with the operator’s hand during normal adjustment, or usage should be smooth.

Joints: Joints of surfaces enclosing combustion products shall not depend primarily on cement for tightness and shall be durable and rigid construction, such as welded, brazed, machined and bolted, tongue-and-groove, slip, lap, or screw joint.

Threaded Parts: Bolts, nuts and screws employed in the assembly of the appliance shall not require the use of special tools for removal or replacement. Bolts, nuts, screws (except sheet-metal screws) and other threaded parts shall have threads conforming to the Standard for Unified Inch Screw Threads, ANSI/ASME B1.1 or the Standard for metric Screw Threads – M Profile, ANSI/ASME B1.13M.

Controls: All controls and accessories including automatic gas ignition systems, piezo-electric spark devices, manual gas valves, automatic valves, gas appliance regulators, pilot gas filters and draft hoods must be certified.

Internal Wirings: All primary, and grounding circuit conductors are CSA/UL certified TEW, TR-64, AWM SR-PVC or AWM XL-PVC, rated min 80°C, 300 VAC. All wiring is suitably routed and secured away from sharp edges and moving parts to prevent chafing of the insulation. Alternatively, additional insulation is provided where the wiring passes over sharp edges and through holes.

Grounding: The green or green/yellow insulated grounding conductor of the power supply cord terminates singly in a crimp type, closed loop connector, secured to the chassis by a min. No. 6 plated or non-ferrous threaded screw, nut and star washer (to ensure surface coating penetration).

Accessibility of Live Parts: All uninsulated live parts in primary circuitry are housed within a metal/plastic enclosure constructed such that any openings are not penetrable by the probe specified in the above-referenced Standard.

Markings: The unit is to be marked with the manufacturer’s name or identifying symbol and address, model number, a distinctive number which will identify an individual appliance (serial number), electrical ratings, and cautionary markings where required. **Products for end-use in Canada may be required to have markings in both French and English. It is the responsibility of the Applicant to determine any such requirement and provide bilingual markings, where applicable, in accordance with the Provincial Regulatory Authorities.**

Installation, Operating and Safety Instructions: Instructions for the proper installation and safe use of this product are provided by the manufacturer. **Products for end-use in Canada may be required to have markings in both French and English. It is the responsibility of the Applicant to determine any such requirement and provide bilingual markings, where applicable, in accordance with the Provincial Regulatory Authorities.**

ELV: All references to "ELV" denote Extra Low Voltage (less than 240 VA and less than 42.4 V pk) energy limited secondary circuits.

Date Issued:	Project No:	Client	Report No:	Revision No:
September 14, 2023	LV-16105	Lance Nill, Inc.	10.02.16105-1	0

ELV Wiring: All non-certified conductors and connectors in ELV sec circuits have insulation materials with a flammability rating of 94V-2 or better or are made of PVC, TFE, PTFE, FEP or Neoprene and are routed and secured away from contacting all primary circuitry.

Dimensions: All dimensions specified are approximations only. Unless stated otherwise, the least significant digit is uncertain by plus or minus one unit.

Polarization: Proper polarization is maintained throughout the equipment on polarized receptacle and load fittings where these devices are conductively connected to the supply.

Sleeving: All thermoplastic and other insulating tubing used in primary circuits are Certified/ULR, rated min 105°C, 300 V ac.

Crimp Connectors: All crimp type connectors used in primary, low voltage, secondary, and grounding circuits are Certified vinyl insulated and appropriately sized for the gauge of wire used. Any larger compression lugs are Certified, 600 V rated, and covered with heat shrink tubing if required.

Printed Circuit Boards (PCB): All PCB's are made of Glass base, epoxy resin, carry a Flame Rating of NEMA FR-4/G-10, and are min 1.6 mm thick. All have solder mask and component identification layer.

Segregation: Insulated conductors of different circuits are provided with spacing as specified in spacing above. Insulated conductors are positively maintained away from bare live parts of different circuits, sharp edges and heat producing components.

Soldered Connections: All connections are mechanically secured before soldering.

Strain Relief: Strain relief is to be provided for all conductors leaving an enclosure.

Date Issued:	Project No:	Client	Report No:	Revision No:
September 14, 2023	LV-16105	Lance Nill, Inc.	10.02.16105-1	0

ALTERATION

The manufacturer/applicant agrees to complete all below noted alterations prior to shipping and labeling products with the LC Certification Mark:

1. Unit shall be permanently marked as with the marking noted in the Marking section with permanent adhesive label or permanent integral marking.

Date Issued:	Project No:	Client	Report No:	Revision No:
September 14, 2023	LV-16105	Lance Nill, Inc.	10.02.16105-1	0

MARKING

All markings required by ANSI/CAN/UL 96 (Ed.6) must be permanent consist, as applicable, of the following:

- a) Lightning protection components shall be marked, where it will be plainly visible after installation, with the manufacturer's name, trademark, or other descriptive marking by which the organization responsible for the product is identified.
Exception: Clips and fasteners may be provided with markings on the smallest unit packaging.
- b) Bimetallic connectors shall be marked "Bimetallic", "Bimetal" or "BM" on the connector.
- c) If a manufacturer produces or assembles lightning protection components at more than one factory, each piece shall have a distinctive marking by which it is identified as the product of a particular factory.

To avoid any misunderstanding, market and subject areas of the accredited scope covered by the LabTest Certification Mark must be indicated as shown below.



Conforms to: ANSI/CAN/UL 96 (Ed.6)

Note: Jurisdictions in Canada may require markings to be also in French. It is the responsibility of the Customer to provide bilingual marking, where applicable, in accordance with the requirements of the Provincial Regulatory Authorities. It is the responsibility of the Customer to determine this requirement and have bilingual wording added to the "Markings".

Date Issued:	Project No:	Client	Report No:	Revision No:
September 14, 2023	LV-16105	Lance Nill, Inc.	10.02.16105-1	0

EXAMPLE MARKING LABEL

Markings Example:

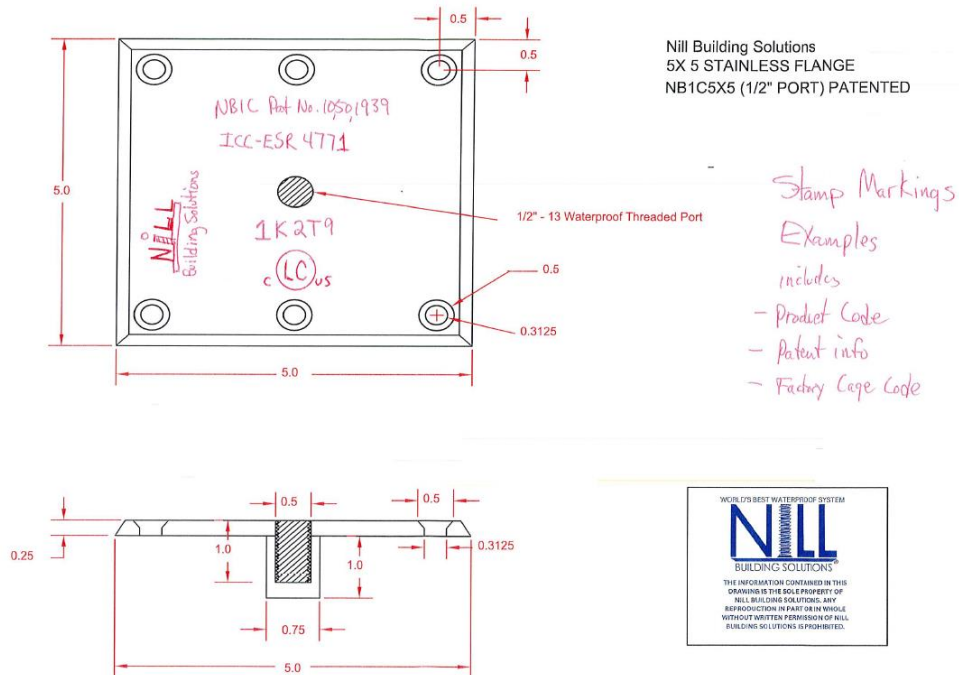

Our products are protected by U.S Patent No. 10,501,939, U.S. Patent No. 11,473,306 & U.S. Patent No. 11,591,799 and/or other U.S. and Foreign patents pending. All Rights Reserved

LabTest Certification Inc. LISTING REPORT



Date Issued:	Project No:	Client	Report No:	Revision No:
September 14, 2023	LV-16105	Lance Nill, Inc.	10.02.16105-1	0

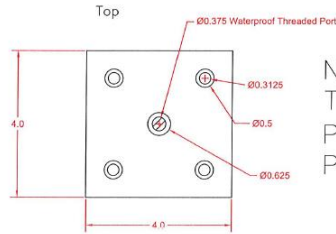

Nill Building Solutions
Threaded Extended
Port Flange (NB56L)
Patent Pending

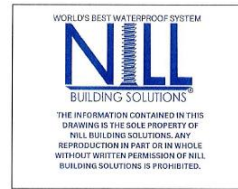
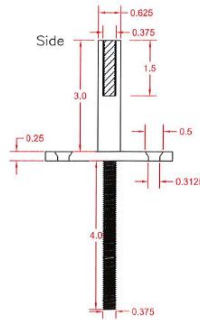
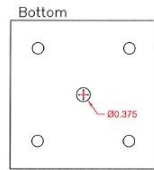
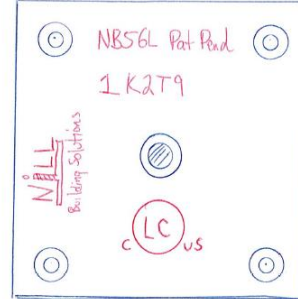

Stamp Markings
Example
With
- Product Code
- Factory Code
- Patent info

Our products are protected by U.S. Patent No. 10,501,939, U.S. Patent No. 11,473,306 & U.S. Patent No. 11,591,799 and/or other U.S. and Foreign patents pending. All Rights Reserved.

LabTest Certification Inc. LISTING REPORT



Date Issued:	Project No:	Client	Report No:	Revision No:
September 14, 2023	LV-16105	Lance Nill, Inc.	10.02.16105-1	0

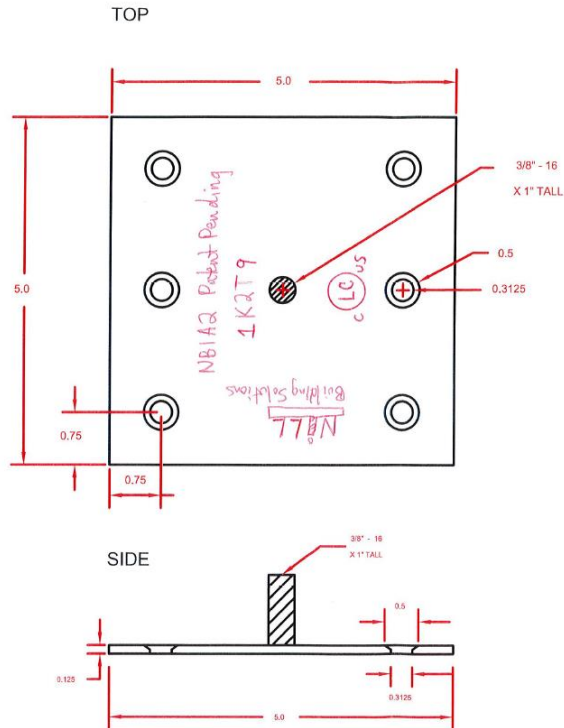

Stamp Markings
Examples
include

NB1A2
"Patent Pending"

- Product Code
- Patent info
- Factory Cage Code

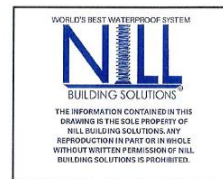

Our products are protected by U.S. Patent No. 10,501,939, U.S. Patent No. 11,473,306 & U.S. Patent No. 11,591,799 and/or other U.S. and Foreign patents pending. All Rights Reserved

Date Issued:	Project No:	Client	Report No:	Revision No:
September 14, 2023	LV-16105	Lance Nill, Inc.	10.02.16105-1	0

NB1DP
 PATENTED

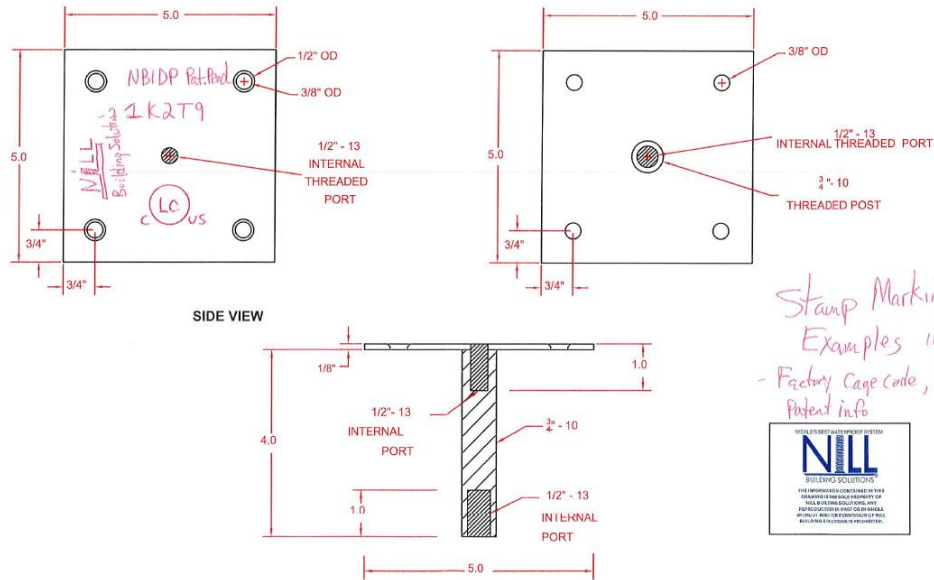

Stamp Markings
 Examples include
 - Factory Cage code, Product code
 Patent info



Our products are protected by U.S. Patent No. 10,501,939, U.S. Patent No. 11,473,306 & U.S. Patent No. 11,591,799 and/or other U.S. and Foreign patents pending. All Rights Reserved

Date Issued:	Project No:	Client	Report No:	Revision No:
September 14, 2023	LV-16105	Lance Nill, Inc.	10.02.16105-1	0

PRODUCT DESCRIPTION

PRODUCT COVERED

Product Type : Class I Lightning Protection Components
Component Type : Hardware – Anchor Flanges
Models : NB1C, NB1A2, NB1DP, NB56L

PRODUCT GENERAL DESCRIPTION:

All models are of type 304 stainless steel constructional material and are designed to be used as part of a lightning protection system used to protect buildings/structures.

PER MODEL DESCRIPTION:

1. Model NB1C
 - a. Class I Hardware
 - b. Type 304 Stainless Steel
 - c. Railing Anchor Flange
2. Model NB1A2
 - a. Class I Hardware
 - b. Type 304 Stainless Steel
 - c. Solar Panel Anchor Flange
3. Model NB1DP
 - a. Class I Hardware
 - b. Type 304 Stainless Steel
 - c. Lightning Rod Anchor Flange
4. Model NB56L
 - a. Class I Hardware
 - b. Type 304 Stainless Steel
 - c. Lightning Rod Anchor Flange

Date Issued:	Project No:	Client	Report No:	Revision No:
September 14, 2023	LV-16105	Lance Nill, Inc.	10.02.16105-1	0

FIGURES / DIAGRAMS

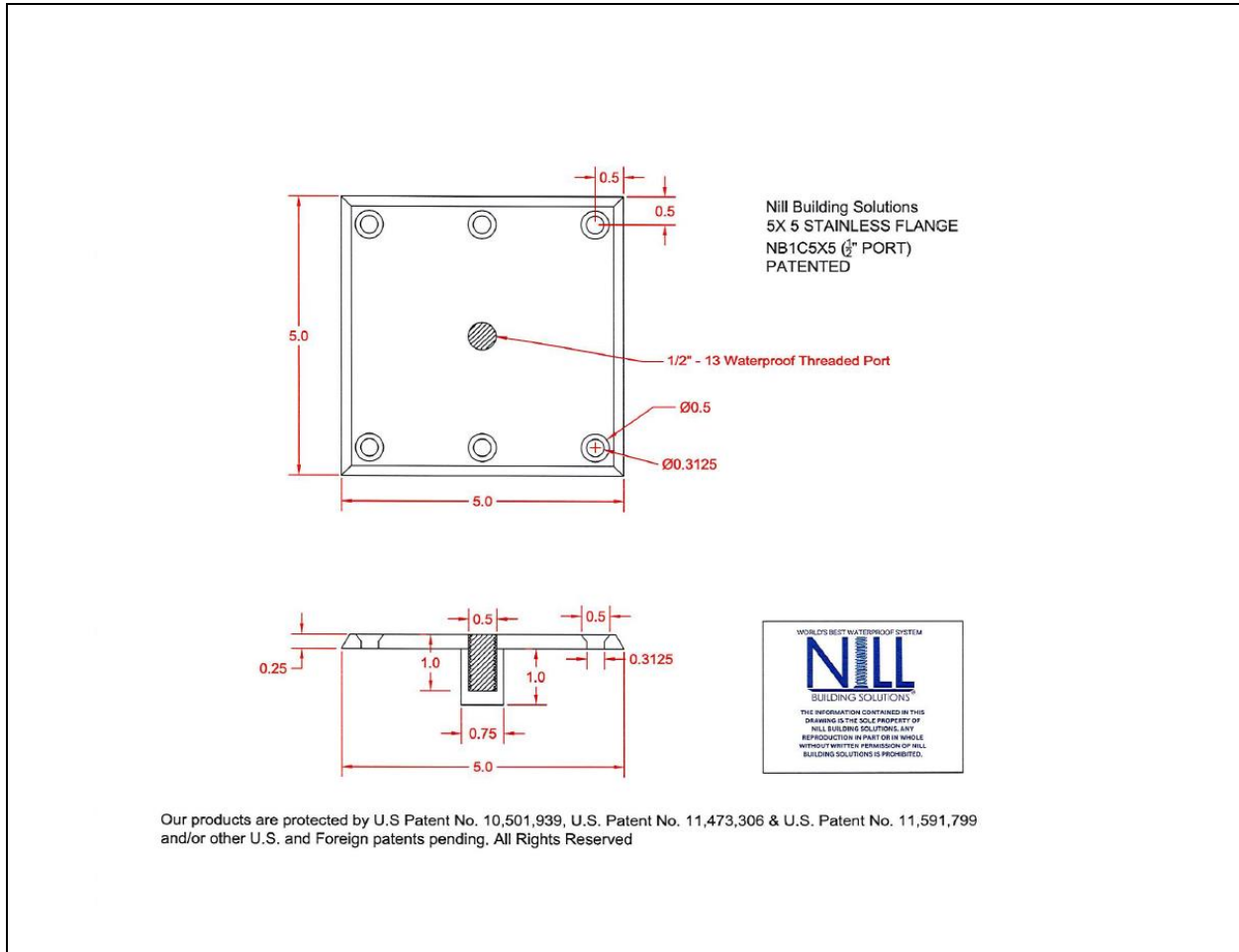

Figure 1 – NB1C Model

Date Issued:	Project No:	Client	Report No:	Revision No:
September 14, 2023	LV-16105	Lance Nill, Inc.	10.02.16105-1	0

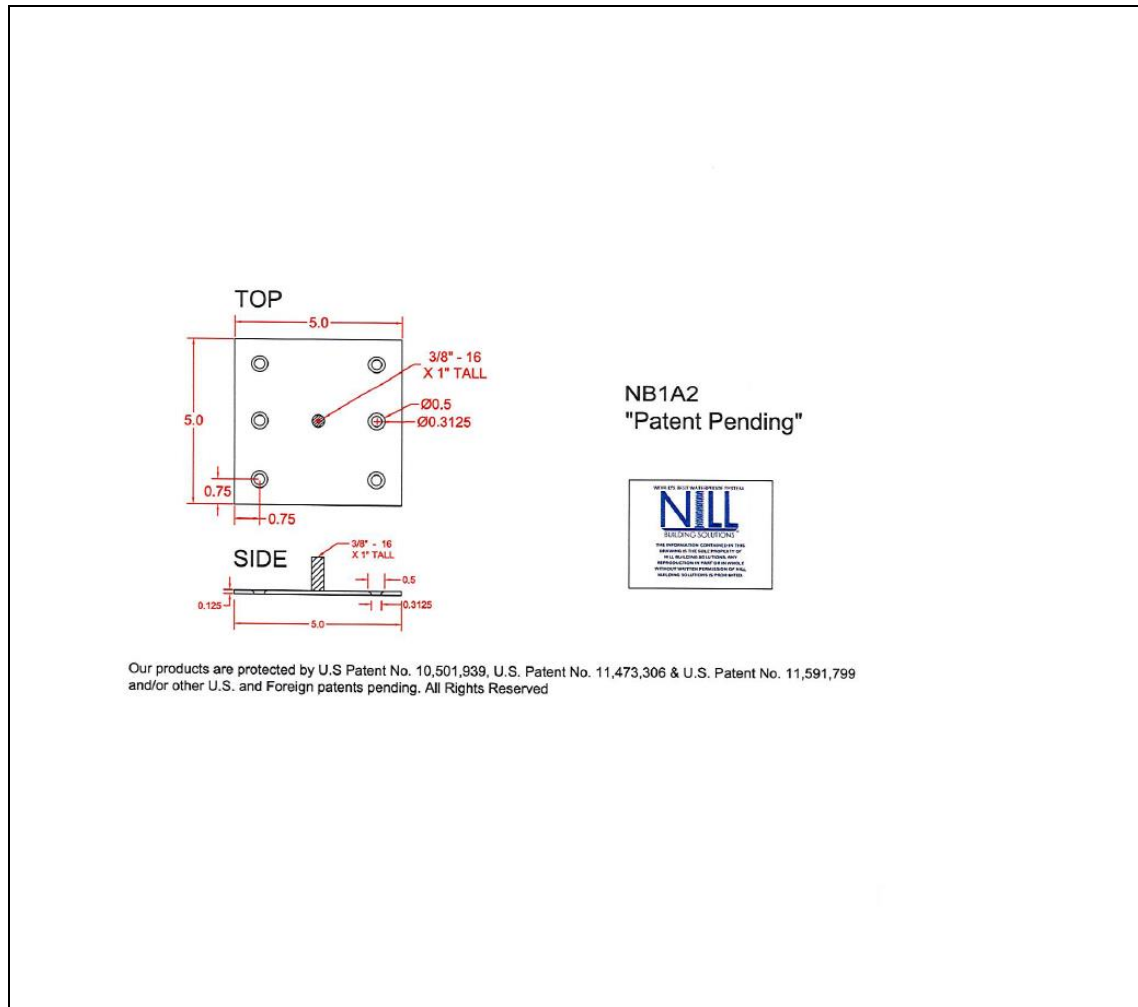

Figure 2 – NB1A2 Model

Date Issued:	Project No:	Client	Report No:	Revision No:
September 14, 2023	LV-16105	Lance Nill, Inc.	10.02.16105-1	0

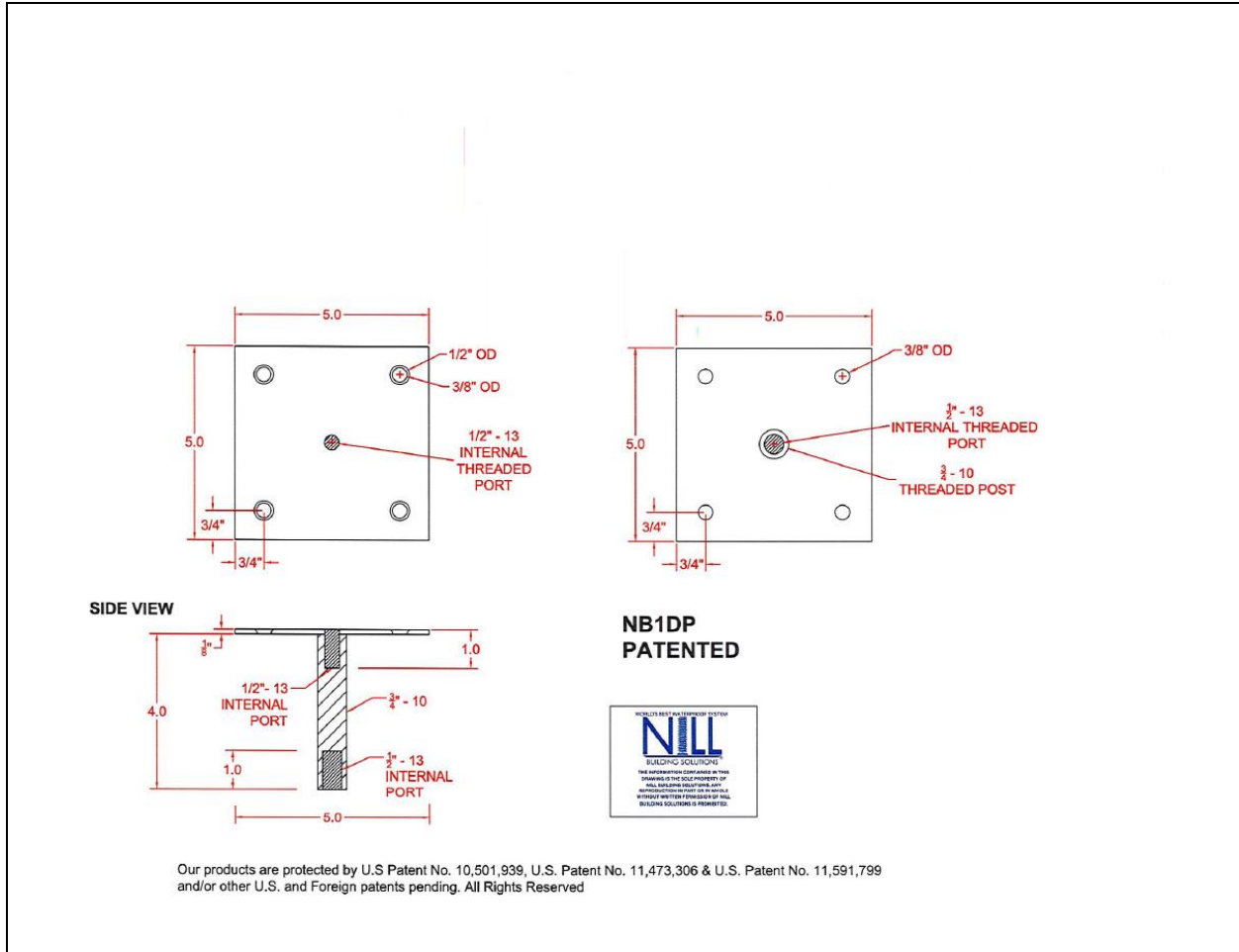

Figure 3 – NB1DP Model

Date Issued:	Project No:	Client	Report No:	Revision No:
September 14, 2023	LV-16105	Lance Nill, Inc.	10.02.16105-1	0

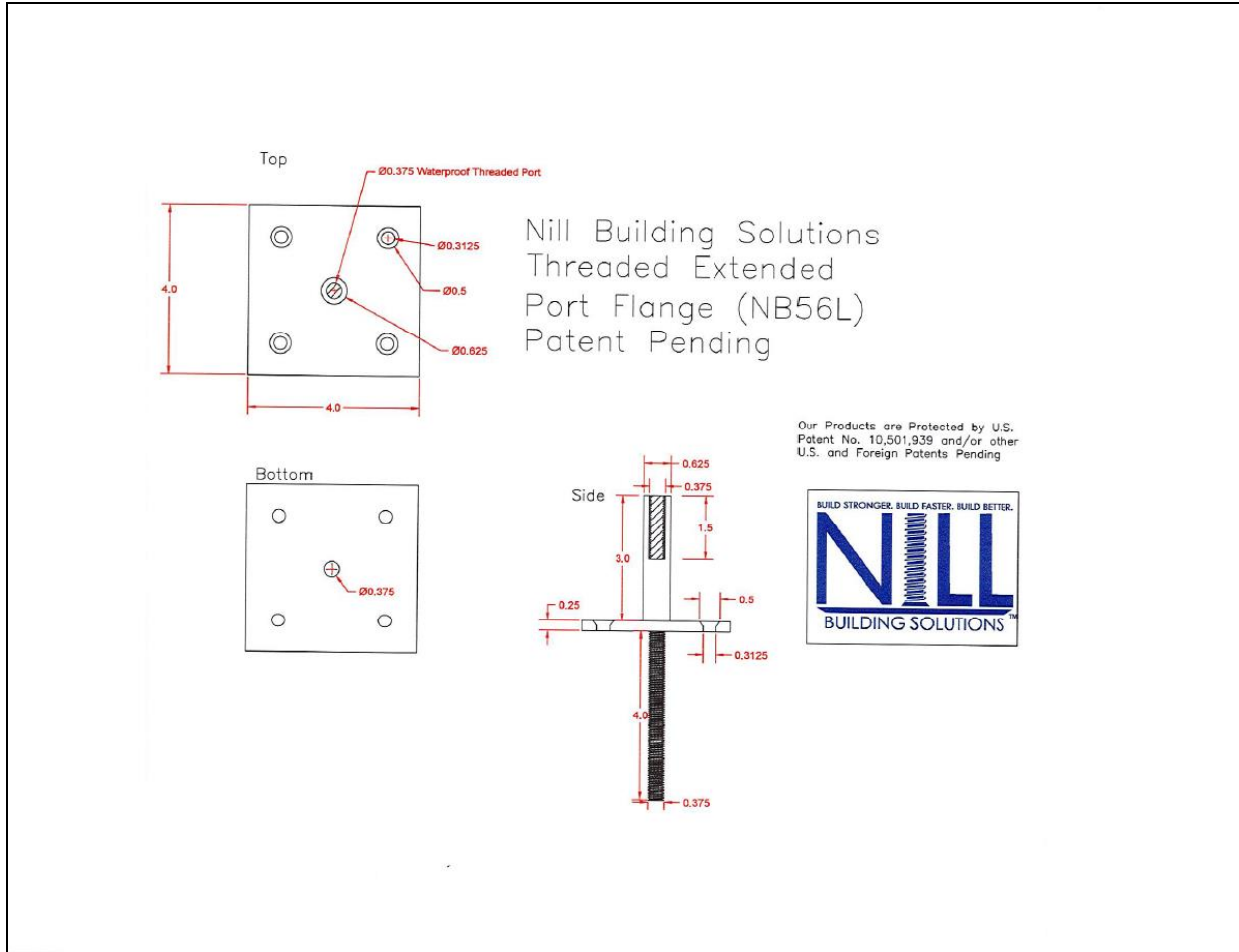

Figure 4 – NB56L Model

Date Issued:	Project No:	Client	Report No:	Revision No:
September 14, 2023	LV-16105	Lance Nill, Inc.	10.02.16105-1	0

PICTURES



Picture 1 – NB1C Model Top Side

Date Issued:	Project No:	Client	Report No:	Revision No:
September 14, 2023	LV-16105	Lance Nill, Inc.	10.02.16105-1	0

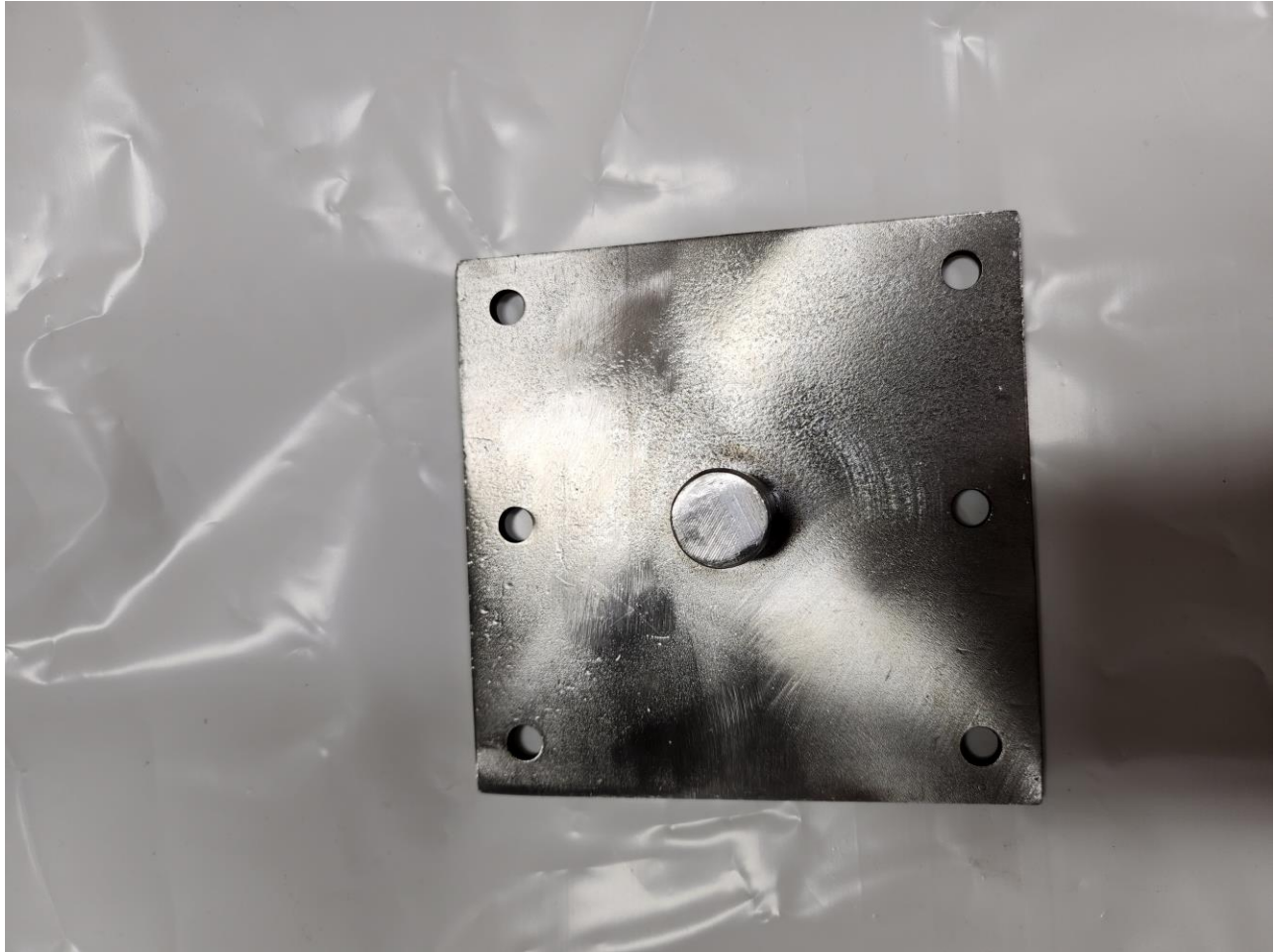

Picture 2 – NB1C Model Bottom Side

Date Issued:	Project No:	Client	Report No:	Revision No:
September 14, 2023	LV-16105	Lance Nill, Inc.	10.02.16105-1	0

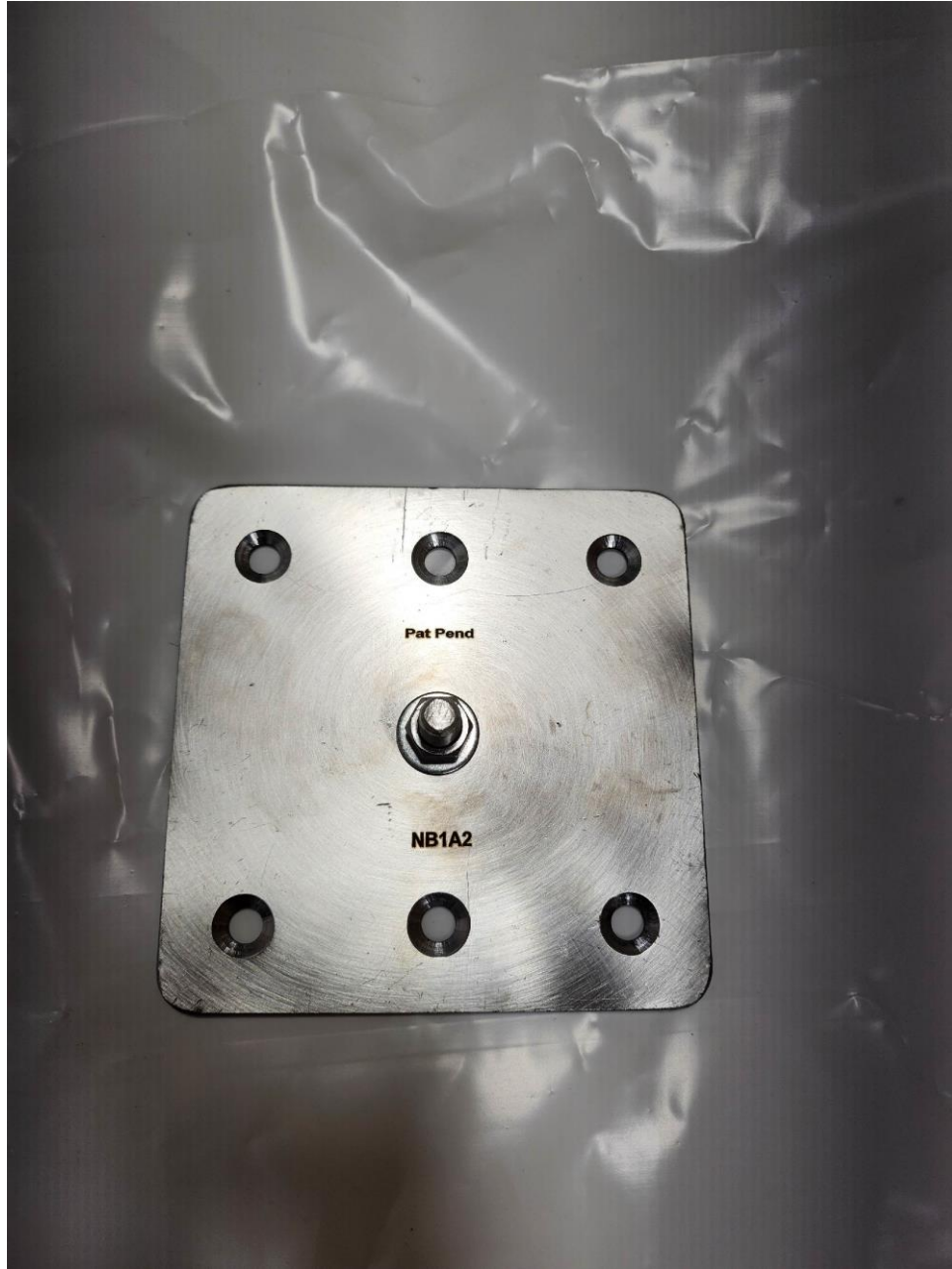

Picture 3 – NB1A2 Model Top Side

Date Issued:	Project No:	Client	Report No:	Revision No:
September 14, 2023	LV-16105	Lance Nill, Inc.	10.02.16105-1	0



Picture 4 – NB1A2 Model Bottom Side

Date Issued:	Project No:	Client	Report No:	Revision No:
September 14, 2023	LV-16105	Lance Nill, Inc.	10.02.16105-1	0



Picture 5 – NB1DP Top Side

Date Issued:	Project No:	Client	Report No:	Revision No:
September 14, 2023	LV-16105	Lance Nill, Inc.	10.02.16105-1	0

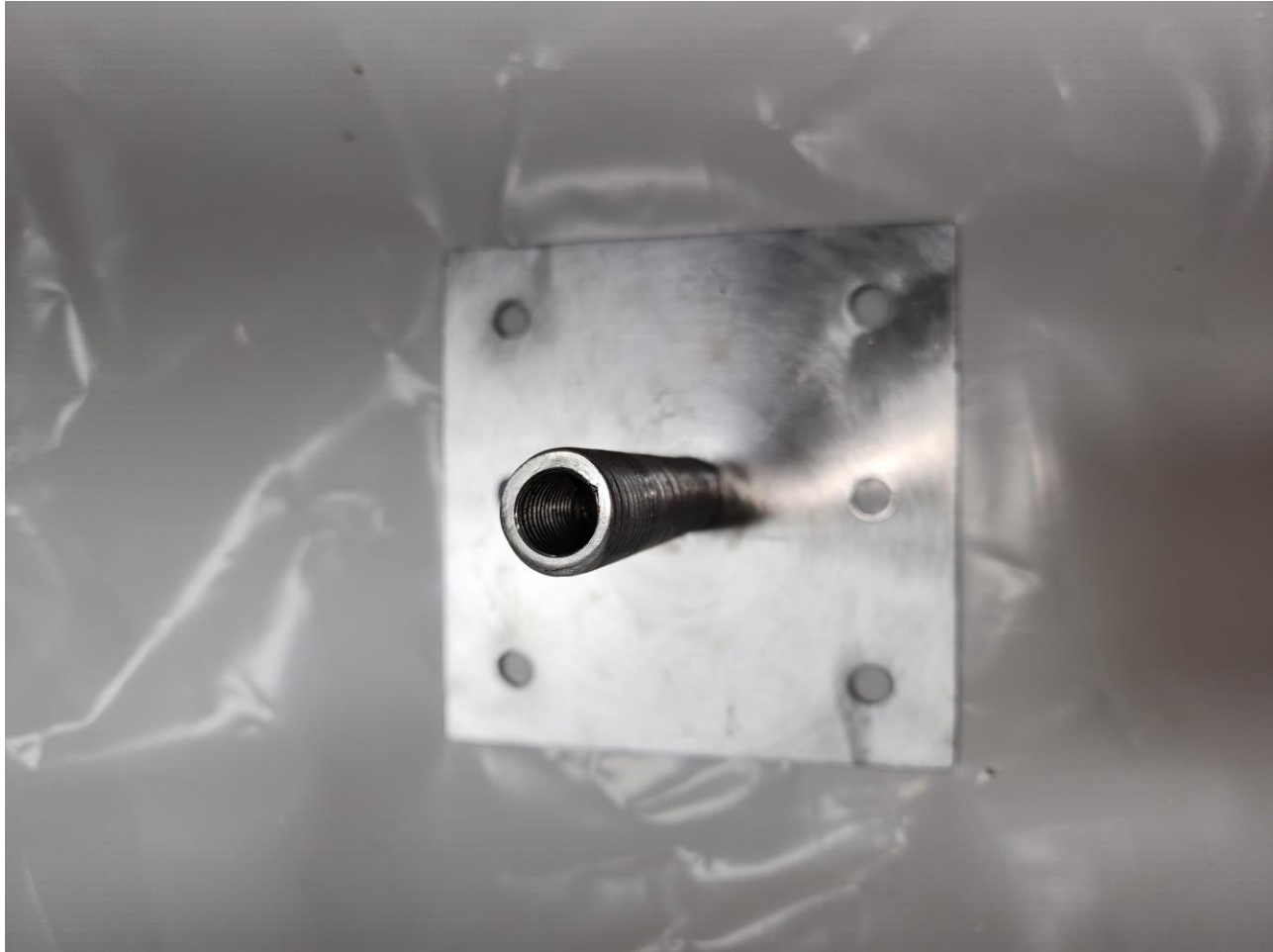

Picture 6 – NB1DP Bottom Side

Date Issued:	Project No:	Client	Report No:	Revision No:
September 14, 2023	LV-16105	Lance Nill, Inc.	10.02.16105-1	0



Picture 7 – NB56L Model Top Side

Date Issued:	Project No:	Client	Report No:	Revision No:
September 14, 2023	LV-16105	Lance Nill, Inc.	10.02.16105-1	0



Picture 8 – NB56L Model Side View

Date Issued:	Project No:	Client	Report No:	Revision No:
September 14, 2023	LV-16105	Lance Nill, Inc.	10.02.16105-1	0

FACTORY PRODUCTION TESTS

FOLLOW-UP SERVICE INSPECTIONS

The LabTest Certification Inc. Field Representative shall determine that the product is manufactured in accordance with this Report, and that label procedures are followed.

Label Control - Record serial numbers of labels if applicable, in the plant. Inspect label log sheets. The following information should be recorded in the label log sheets by the manufacturer:

1. Label numbers, product labeled, date labeled or shipped, and destination.
2. Labels removed from, returned, freight damage, or rejected products should be picked up.

Examination of Product - At each Follow-up Service Inspection the LabTest Field Representative shall determine that the product which is intended to bear the LabTest Certification Mark is manufactured in accordance with the specified standards as per the test program and stated herein. The LabTest Field Representative shall pay special attention to the following:

1. Materials used must be free from defects that could affect the performance of the product.
2. Suitable protective packaging.
3. Complete Safety and Installation Instructions are supplied with each product. No modification to these instructions shall be made without LabTest authorization.

Examination of Applicant's Inspection Programs - At each Follow-up Service Inspection, the LabTest Field Representative shall determine that the Applicant's methods of inspection conform to the specifications included in the quality control procedures. The LabTest Field Representative will pay attention to:

1. The Applicant's Quality Control report is complete and conforms to the procedure accepted by LabTest and included in this Report.
2. The equipment used for inspection conforms to the specification in the quality control procedure.
3. The work area is suitable for a good quality control program.
4. Regular manufacturing production line tests are carried out by the Applicant.

Periodic unannounced Follow-up Service Inspections of the manufacturing facility shall be conducted by LabTest Certification Inc. A Follow-up Service Inspection Report shall be issued after each visit. Special attention will be given to the following:

1. Conformance of the manufactured product to the descriptions in this Report.
2. Conformance of the use of the LabTest Certification Mark with the requirements of this Report and the LabTest Certification Agreement.
3. In-plant quality control procedures and personnel.
4. Manufacturing processes and changes.
5. Performance of specified Manufacturing and Production tests.

Date Issued:	Project No:	Client	Report No:	Revision No:
September 14, 2023	LV-16105	Lance Nill, Inc.	10.02.16105-1	0

In the event that the LabTest representative identifies non-conformance(s) to any provision of this Report, the Applicant shall take one or more of the following actions:

- Correct the non-conformance(s).
- Remove the LabTest Certification Mark from non-conforming product.
- Contact the LabTest Certification Inc. office that issued this Report for additional instructions.

Records - Records of the use of the LabTest Certification Mark must be maintained by the Applicant and must be available for review during normal business hours.

Shipping - As practically as possible, each Listed product is to be shipped completely assembled and incorporate the necessary safety and installation instructions.

The manufacturer shall check, inspect and test the components and the assemblies, of each appliance in the following manner:

- Inspect all raw materials and purchased components.

The results of these tests shall be recorded and maintained by the manufacturer for review by LabTest Certification Inc.

Date Issued:	Project No:	Client	Report No:	Revision No:
September 14, 2023	LV-16105	Lance Nill, Inc.	10.02.16105-1	0

DATA SECTION

The product samples listed in the following Evaluation and Test Checklists were considered representative of all models covered in this Listing Report and were tested for compliance with the standard clauses as listed below:

EVALUATION AND TEST CHECKLIST No.: 1

Project No:	LV-16105	Product:	Lighting Protection Components – Anchor Flanges
Model No(s):	NB1C, NB1A2, NB1DP, NB56L	Sample No:	7015, 7016, 7017, 7018
<input type="checkbox"/> Test Data Transferred from:	N/A	(Tests were conducted by an ISO 17025 accredited test lab recognized by Standard Council of Canada)	
<input checked="" type="checkbox"/> Standard used:	ANSI/CAN/UL 96 (Ed.6)	(use a separate checklist for each standard)	
Testing Location:	LabTest Certification, Inc.	Date:	August 1, 2023 through August 21, 2023
Standard Clause	Requirement / Test	Evaluation / Test Results	Verdict
6 – 18	Class I Components	The evaluation results comply with the requirements of the standard	P
29	Security of Components	The evaluation results comply with the requirements of the standard	P
30	Instructions	The evaluation results comply with the requirements of the standard	P
31	Markings	The evaluation results comply with the requirements of the standard	P

END OF REPORT